

Thomson Electrak® Smart Linear Actuators

Electromechanical Solutions for Intermittent Duty Cycle Automation



DISTRIBUIDOR
AUTORIZADO

MEX (55) 53 63 23 31 MTY (81) 83 54 10 18
QRO (442) 1 95 72 60 ventas@industrialmagza.com

THOMSON®

Linear Motion. Optimized.™

Designing Smart Machines Starts with Smart Tools

As the industrial world becomes increasingly connected, the designer's need for intelligent components that can communicate with each other and operate without the need for manual interaction is growing. Thomson, a trusted manufacturer that has always been committed to staying ahead of the technology curve, is meeting this demand and helping to usher in a new generation of "smart" actuators.

What is Smart Actuation?

The crux of smart actuation begins with the integration of onboard electronics, which enables enhanced control functions that were previously external, such as switching, position feedback and system diagnostics, directly into the actuator. Newer actuators from Thomson incorporate microprocessor-based printed circuit boards with complementary software which allows communication between remote networks.

Benefits

- Increased efficiency and productivity.
- Enhanced diagnostic capabilities and controllability.
- Fewer components and less cabling.
- Minimized complexity and easier installation.
- Reduced hardware and software costs.
- Decreased machine development time and weight.
- Improved machine functionality and performance.

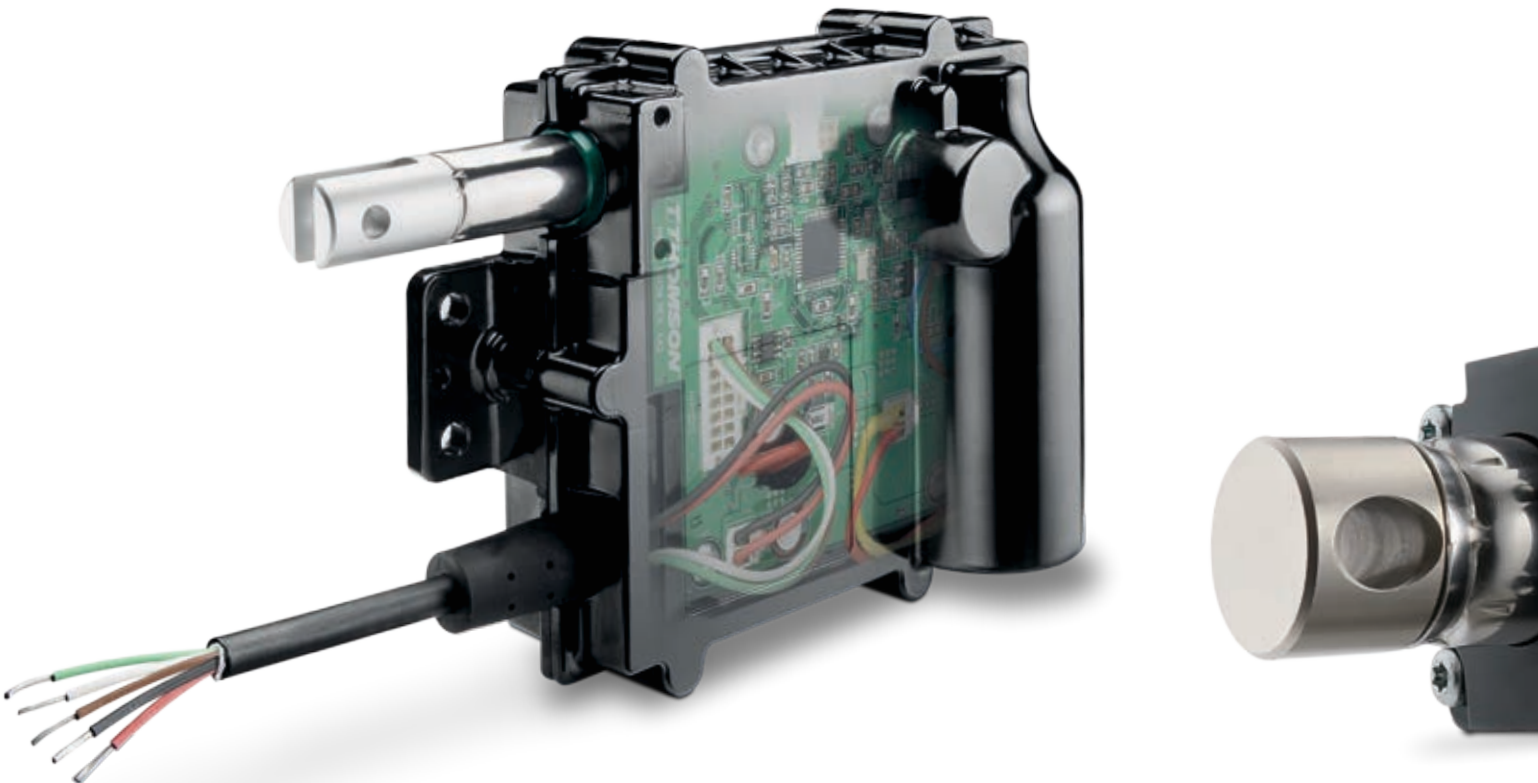

SMART ACTUATION

IMPROVE

**EFFICIENCY
DIAGNOSTICS
PRODUCTIVITY
PERFORMANCE
CONTROLLABILITY**

REDUCE

**COMPLEXITY
ENGINEERING
COMPONENTS
OVERALL COSTS
INSTALLATION TIME**



Reaching New Markets

Smart actuators are increasingly finding their way into applications that were once dominated by pneumatic and hydraulic systems. The mobile off-highway (MOH) vehicle market was among the first to deploy electric actuators for enhanced control and automation capabilities available in the field. However, other industries have begun to realize the many benefits of smart actuation.

Factory Automation

- Safer and cleaner environment, highlighted by elimination of hydraulic fluid leaks.
- Bus communication, low-level switching, intermittent duty cycles and high power density in a compact envelope.
- Improved efficiency of preventive maintenance programs and reduced downtime due to condition monitoring.
- Reduction of malfunctioning or worn parts through elimination of hydraulic pumps, valves and hoses.
- Simplified control with monitoring of operation-critical parameters.
- Cost savings via removal of external switches and controls, reduction in installation time, and lack of power consumption without load.
- Increased design flexibility by modifying input parameters when an actuator is used for different applications.

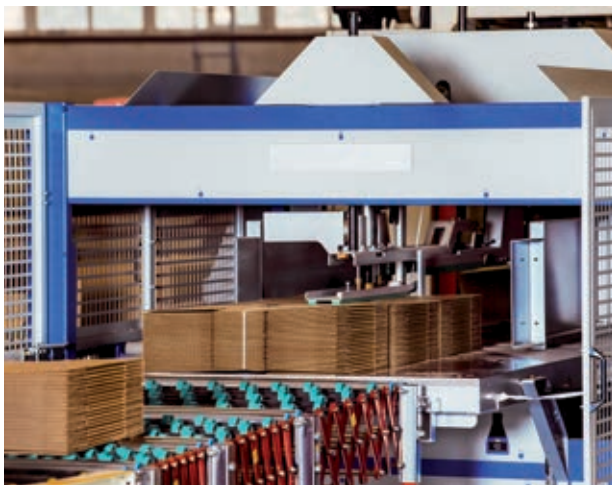

Construction and Agricultural Equipment

- Simplified, less expensive system design due to integration of external control boxes, fewer wires and quick connection to existing networks.
- Increased motion control capabilities via position feedback and out-of-the-box options for bus communication.
- Cleaner environment as a result of no fluids, chemicals or solvents necessary for operation.
- Robust and reliable operation, even in demanding environments, enabled by Thomson high testing standards.
- Increased operator safety as processes can be done from inside the machine cabin.



Material Handling

- Advanced position control and switching enable an infinite number of movement profiles and custom motion strategies.
- High power density makes equipment more compact and battery powered machines more efficient.
- Safer and cleaner environment, highlighted by elimination of hydraulic fluid leaks.
- No need for hefty power supply or relay for control.
- Less stress is put on system batteries and charging systems due to onboard low-level switching, which uses low-current signals to control the travel.
- Robust and reliable operation, even in demanding environments, ensured by Thomson high testing standards.
- Easy installation and maintenance from a plug-and-play, turnkey solution.
- Greater capability to synchronize operations among multiple actuators, including configuration of start-and-stop instruction.



Domestic, Office and Hospital Equipment

- Manual-to-electromechanical conversion assists with load and ergonomics.
- No manual lifting saves time and eliminates strain for users/patients.
- Programmable positions, including sitting and standing at a workstation or desk, are possible.
- Safer and cleaner environment, highlighted by elimination of hydraulic fluid leaks.
- Using the battery as a power source frees you from having to use wall outlets.
- Saves energy due to lack of power consumption when holding a static load.
- Easy to integrate into home automation systems compared to other mechanical solutions.
- Enhanced safety with several connected axes able to communicate with each other and interlock functionality.



Smart Actuation Feature Breakdown

It's all about control. With onboard electronics allowing you to make standalone controls a thing of the past, a new world of interconnected possibilities awaits your machine designs. The Thomson Electrak® Modular Control System (EMCS) is the foundation for the best onboard controls currently available in electric linear actuators and includes standard and optional features such as built-in J1939 CAN bus support. This level of control helps save design and installation time, as well as space and installation cost. Plus, a generous selection of control configurations can tailor your smart actuator to fit a wide breadth of heavy duty applications.



When positioning a sky lift basket, using smart actuators makes it possible to limit movements and avoid potential dangers.

Low-Level Switching



Onboard electronics limits current draw at switches or contacts to a maximum of 22 mA, enabling a simplified and less expensive system design. These low-current signals can be used to program actuators to extend, retract or stop the tube, providing a soft start. This improves safety by reducing the hazard of electrical shock and puts less stress on system batteries and charging systems. An auto sleep feature also helps improve efficiency by reducing power consumption during idle or dwell periods.

Analog Position Feedback



A high-quality potentiometer with essentially infinite resolution and low noise provides a voltage signal for position and direction feedback.

Digital Position Feedback



An encoder provides either a single or double channel pulse train for position and speed feedback, which can be used to synchronize actuators via customer control.

Synchronization



This option (integrated into Electrak HD/available via external DCG control for WhisperTrak™) allows up to four actuators to share a load. Designers are able to take advantage of a more stable and potentially quicker lift, no additional guides, and improved handling of uneven loads. With these controls integrated into the Electrak HD actuators, installation and system wiring are simplified.

Monitoring and Diagnostics

Constant monitoring of critical parameters such as voltage, speed, force and temperature protects the actuator and machine by preventing motion if outside normal ranges. Current monitoring is a critical safety feature that shuts down the actuator on overload and eliminates the need for the traditional noisy mechanical clutch. Internal end-of-stroke limit switches are built into select actuators to ensure smooth, repeatable operation and protect both connected equipment and the actuator.

Simplified Control Architectures

When adding CAN bus, your control system and actuators can communicate directly with each other. The installation is fast and easy, requiring only a two-wire bus cable and power to extend the network, and any other equipment with CAN bus can be connected for additional communication. The result is a less complex system to design, better performance and controllability, and reduced installation time and overall cost.

Remote Access and Communication Protocols

Integrated electronics make it possible for actuators to apply networking standards, such as J1939, a high-level communications protocol that provides a standard messaging structure for communications among network nodes under control of an electronic control unit. While J1939 is popular for off-highway applications, actuators with integrated electronics are increasingly applied in plant floor, material handling and other applications.

Electrak HD



Electrak Throttle

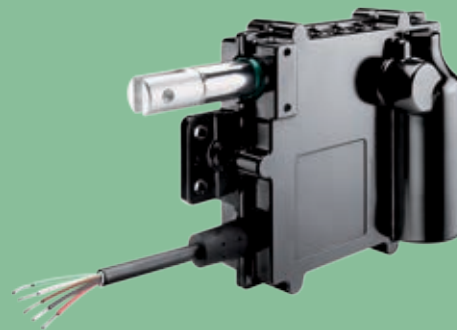

WhisperTrak

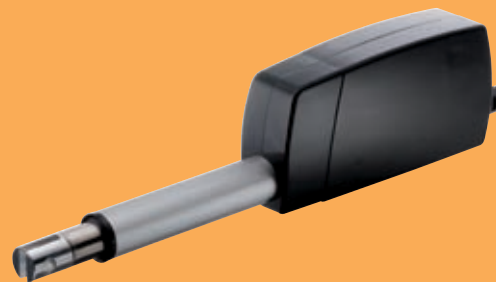

Building a Smarter Factory

An interconnected factory is a productive, efficient factory. Once smart actuation is introduced into a facility's automation process, the benefits are immediate and exponential. Machine design is simplified with increased flexibility and plug-and-play functionality, control capabilities are enhanced, energy usage is decreased, maintenance and downtime experience significant reductions, safety and ergonomics improve, and overall costs are lessened.

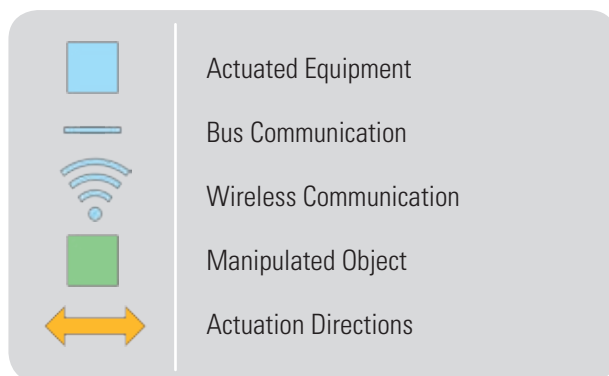
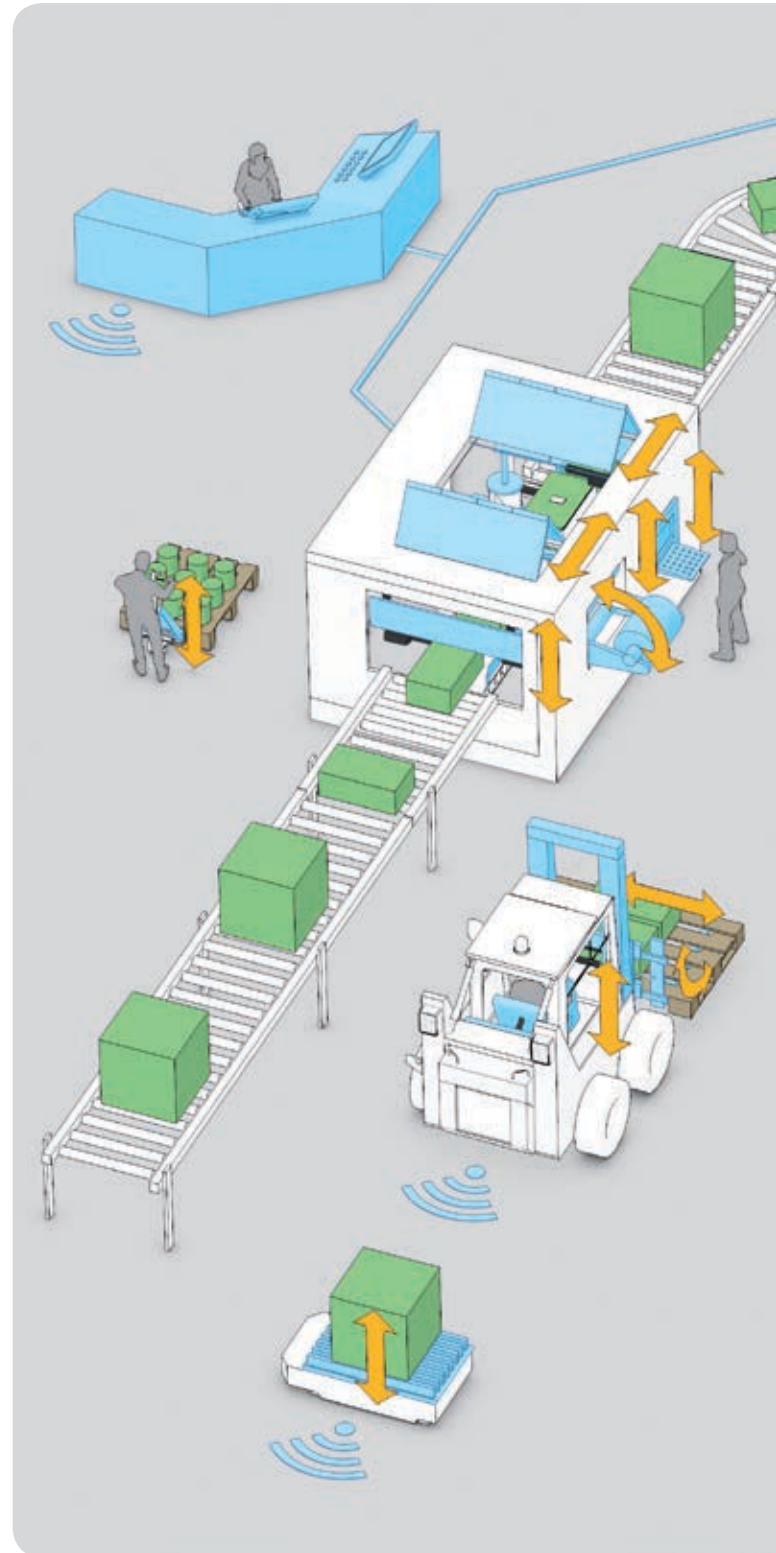

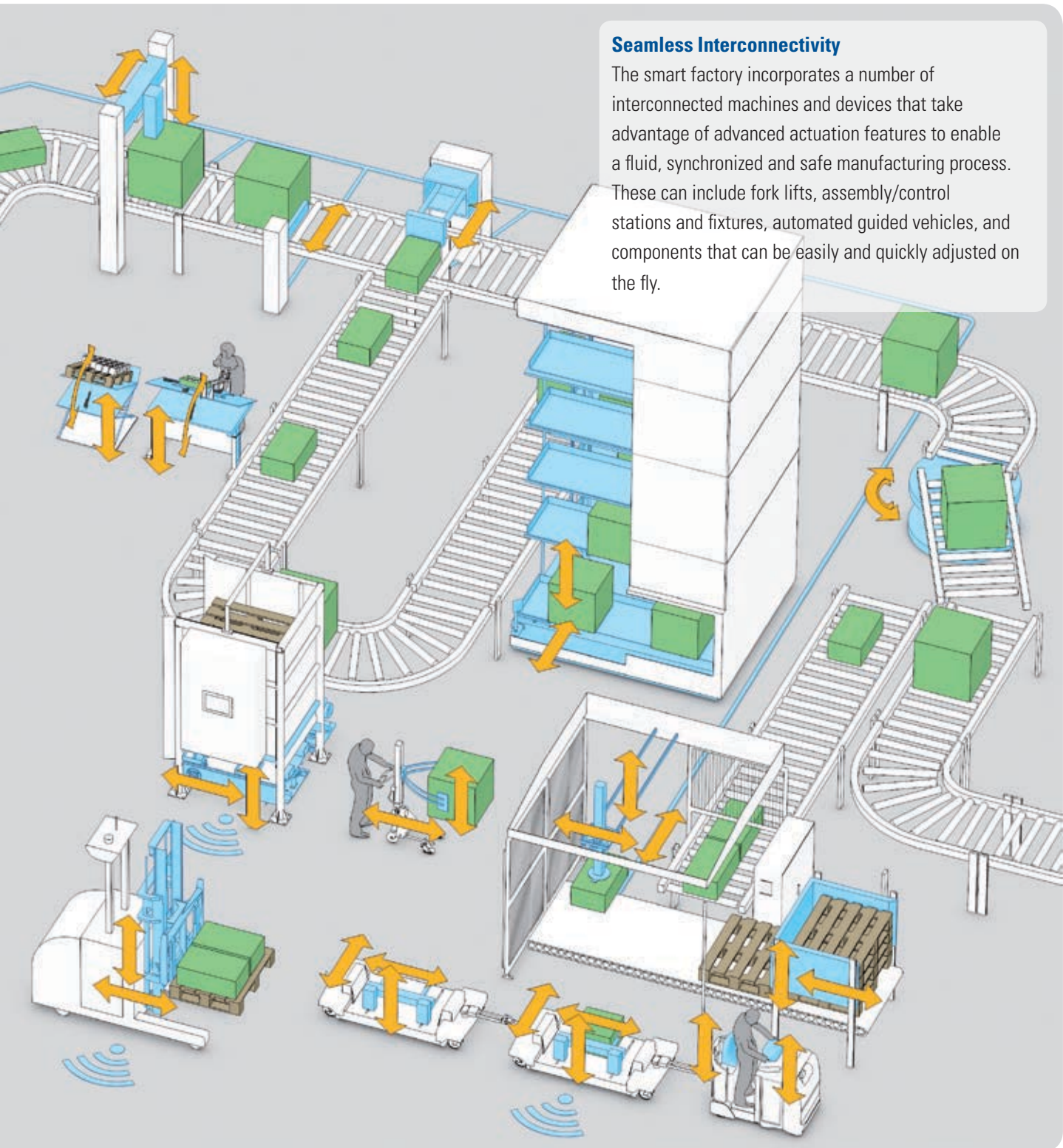

Seamless Interconnectivity

The smart factory incorporates a number of interconnected machines and devices that take advantage of advanced actuation features to enable a fluid, synchronized and safe manufacturing process. These can include fork lifts, assembly/control stations and fixtures, automated guided vehicles, and components that can be easily and quickly adjusted on the fly.

For further detail on factory applications that benefit from smart actuation, see the next page.

A Closer Look at Smart Actuation in the Factory

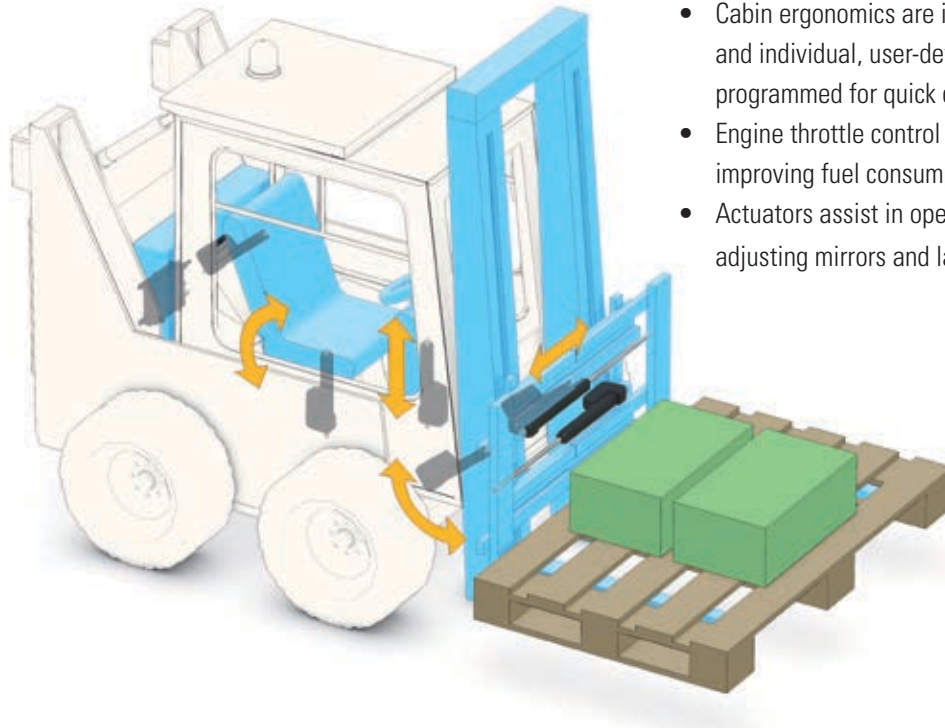

Fork Lifts

- Cabin ergonomics are improved with seat adjustments, and individual, user-defined settings are pre-programmed for quick changes.
- Engine throttle control is more precise and responsive, improving fuel consumption and the user experience.
- Actuators assist in opening hoods and doors, and adjusting mirrors and ladders.

Machine Operation and Safety

- Easy-to-build interlock functions prevent machines from functioning when hatches are open.
- In flexible manufacturing, machines often need to be adjusted when changing the size or type of product being produced. In these instances, bus-controlled actuators are programmed to adjust machine settings (e.g. fences or diverters) according to the processing parameters of that particular product.

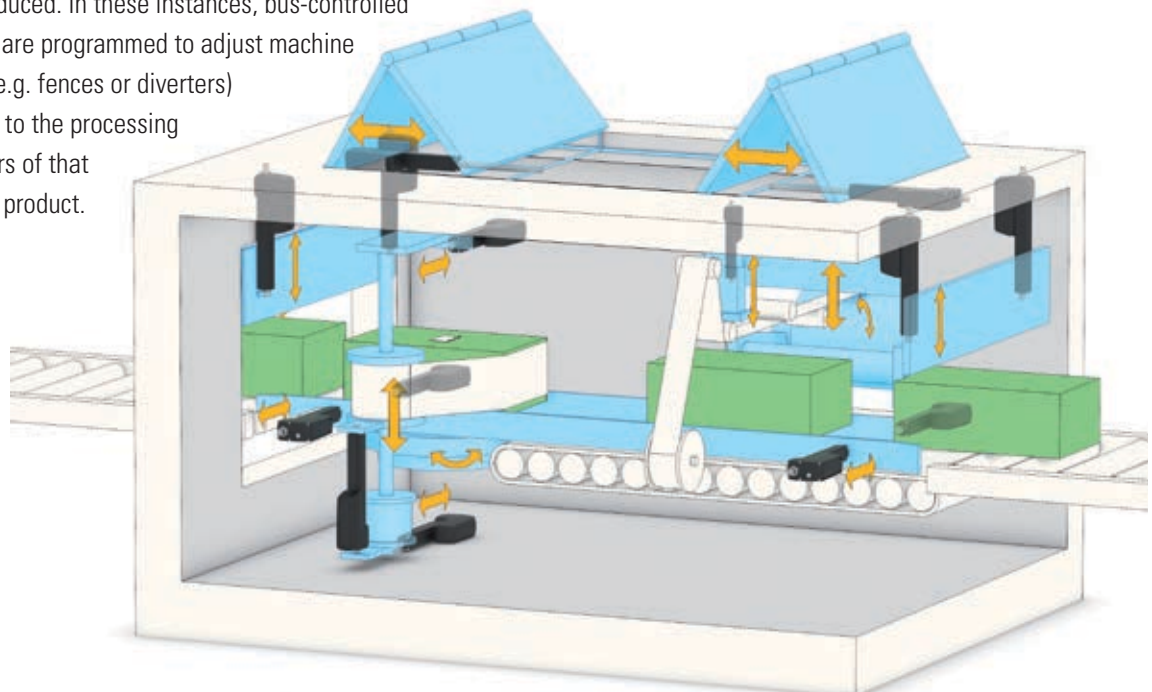

Assembly/Control Stations and Fixtures

- Operators adjust their workplaces to minimize the risk of injury, while securing material and other equipment during the assembly process.
- The burden of heavy and/or repetitive lifts is eliminated.
- Compared to pneumatic or hydraulic solutions, electric actuators achieve improved controllability, greater accuracy, less noise, cleaner operation and reduced operating costs.

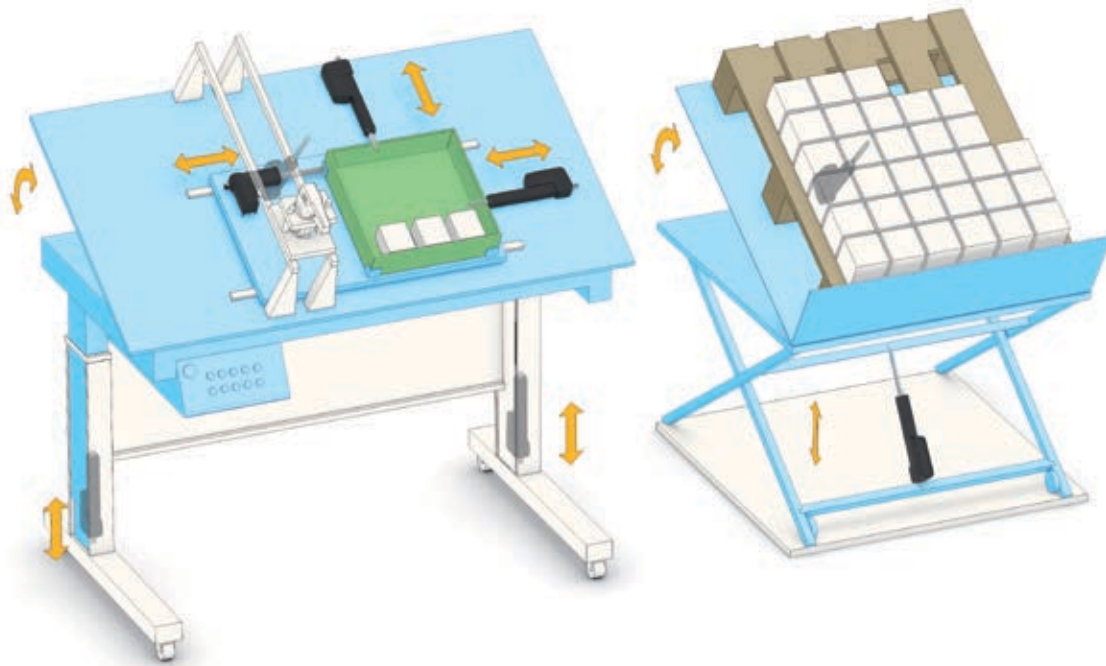

Logistic Trains and Automated Guided Vehicles (AGV)

- Precise control, reliable feedback and no creeping at a standstill allow you to control forks, tools and other functions in order to pick, place and handle material or goods.
- With all functions electrically powered, the complexity of the total system is reduced.
- High loads are held with no power, optimizing the battery life and reducing the charging intervals.

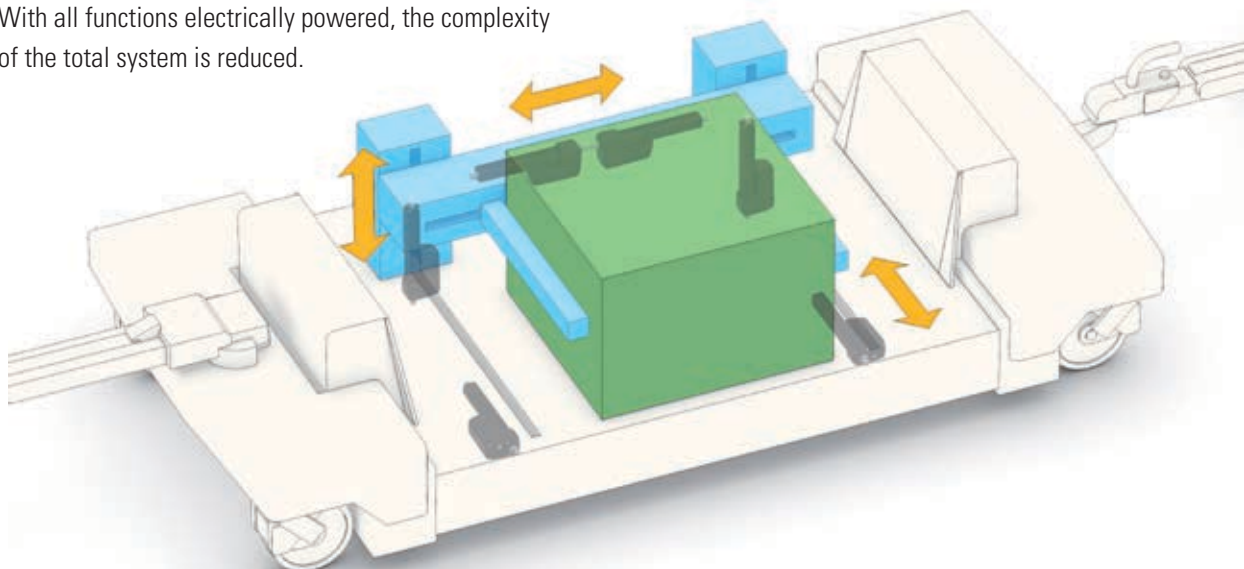

Take Smart Actuation On and Off the Highway

On land, water or any other terrain, efficient linear motion control on vehicles, machines and equipment helps keep businesses moving. In these applications, you will find smart actuation making its biggest impact.

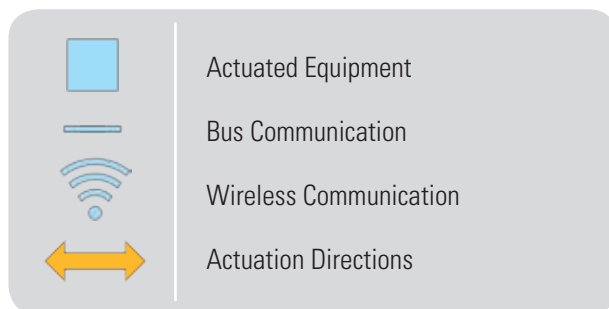
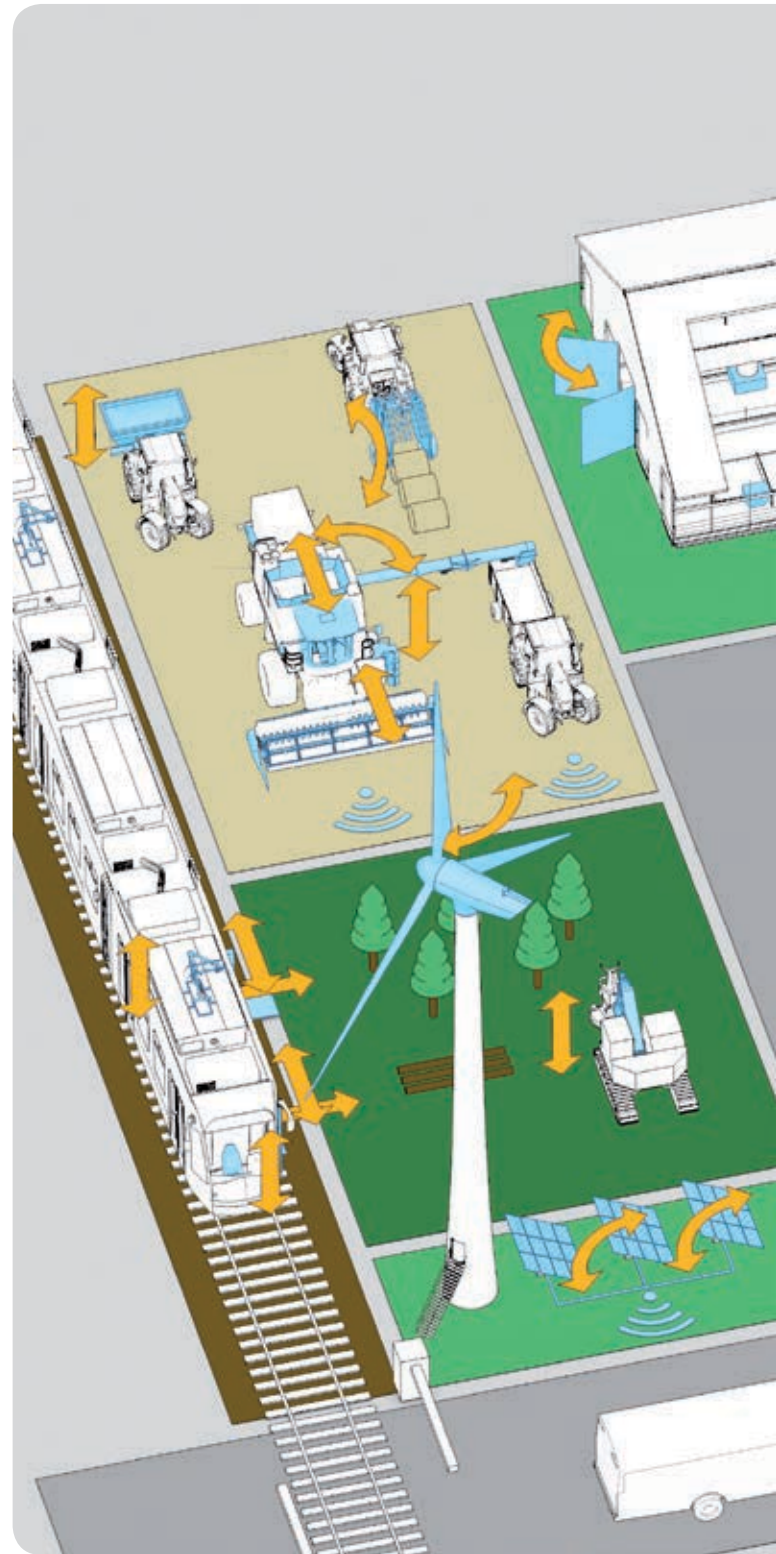

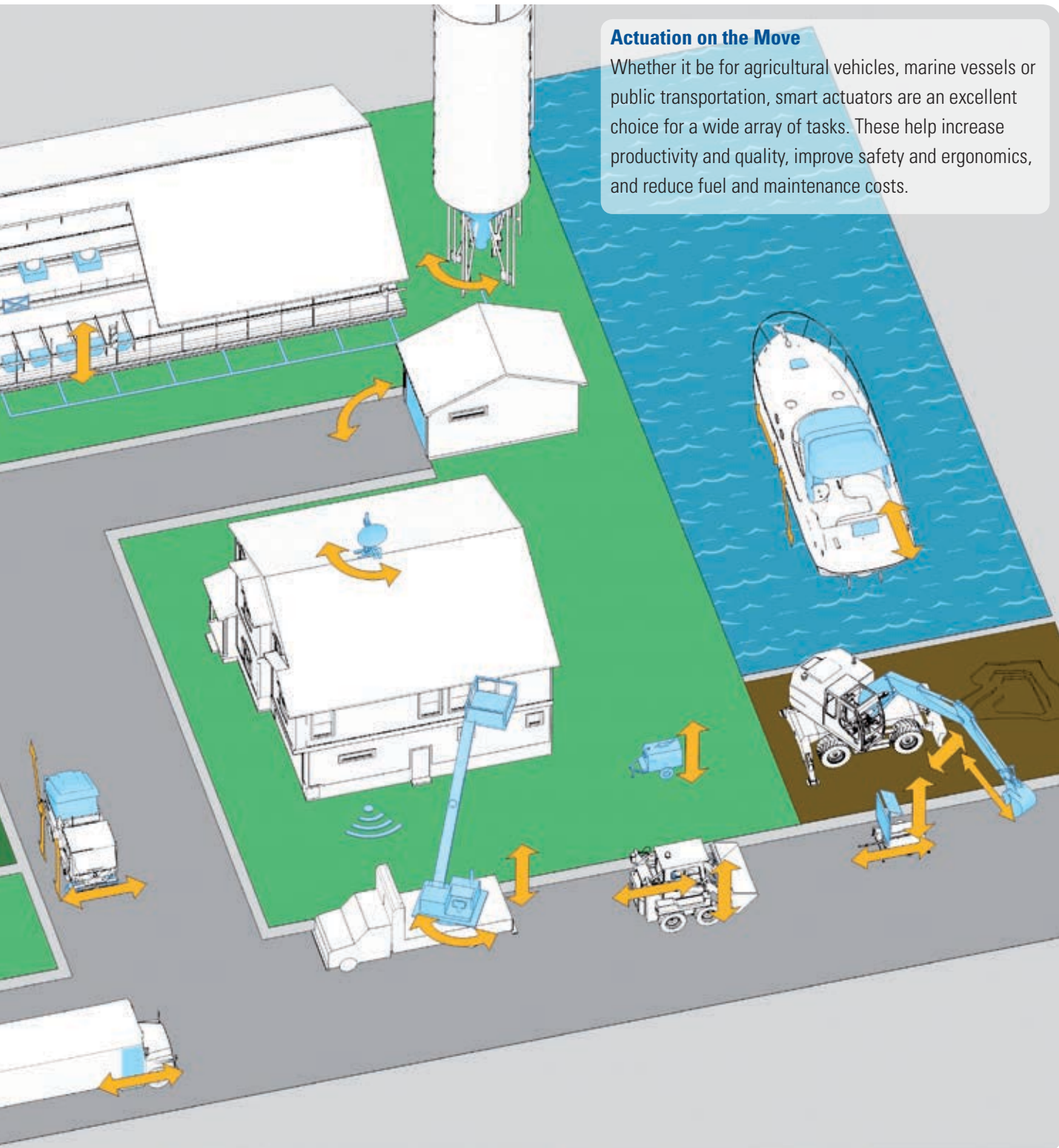

Actuation on the Move

Whether it be for agricultural vehicles, marine vessels or public transportation, smart actuators are an excellent choice for a wide array of tasks. These help increase productivity and quality, improve safety and ergonomics, and reduce fuel and maintenance costs.

For further detail on on/off-highway applications that benefit from smart actuation, see the next page.

Make Your Environment Smarter

Combines

- Electromechanical actuation is ideal for hard-to-reach places that may require complex control to function.
- Integrated electronics allow you to drop in an actuator where a more complicated control scheme for hydraulics or air would have been previously.
- Common applications include sieve leveling, auger tube fold, hood lift and grain bin cover.

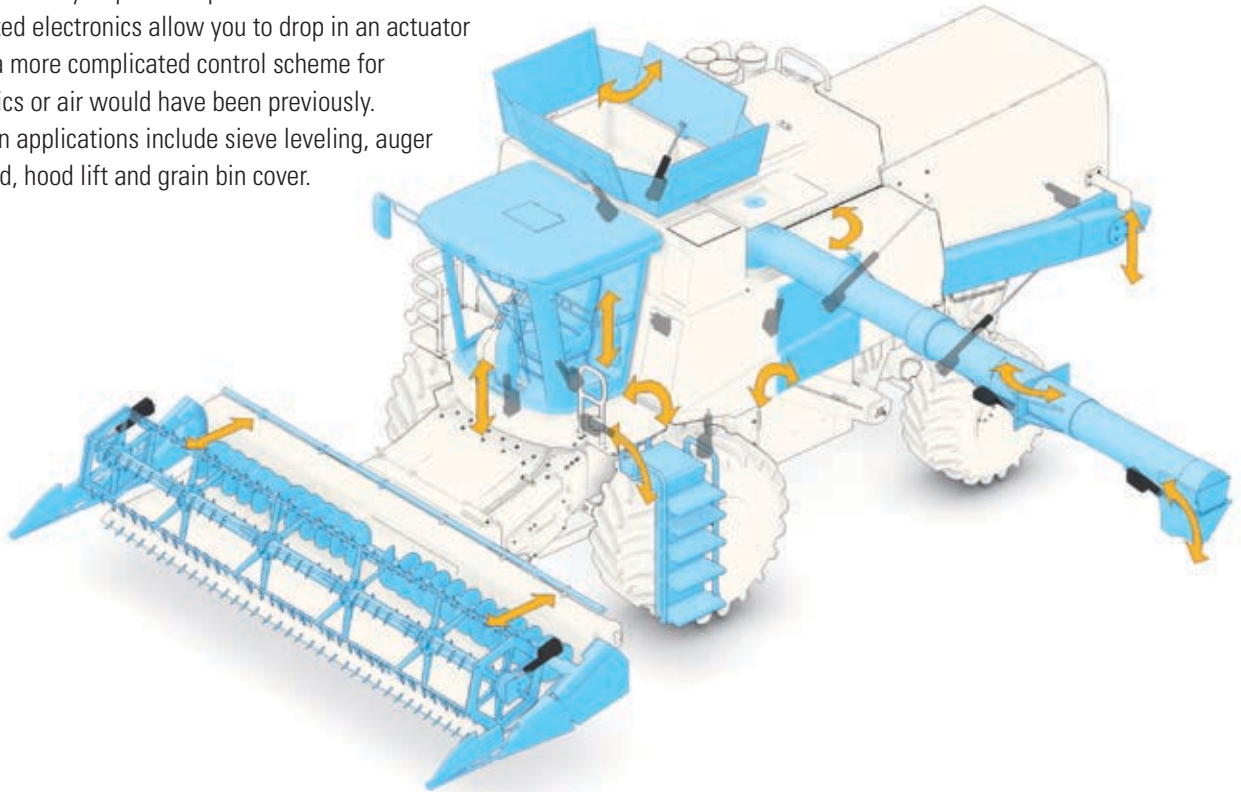

Skid Steer Excavators

- These utilize a quick-attach system to connect and disconnect multiple attachments to the front of the vehicle.
- Reliable Thomson smart actuators integrate into the cab controls to provide the convenience of swapping attachments without having the operator exit the cab.
- Position feedback allows the operator to confirm the implement (i.e. bucket) is securely locked before deploying the machine.

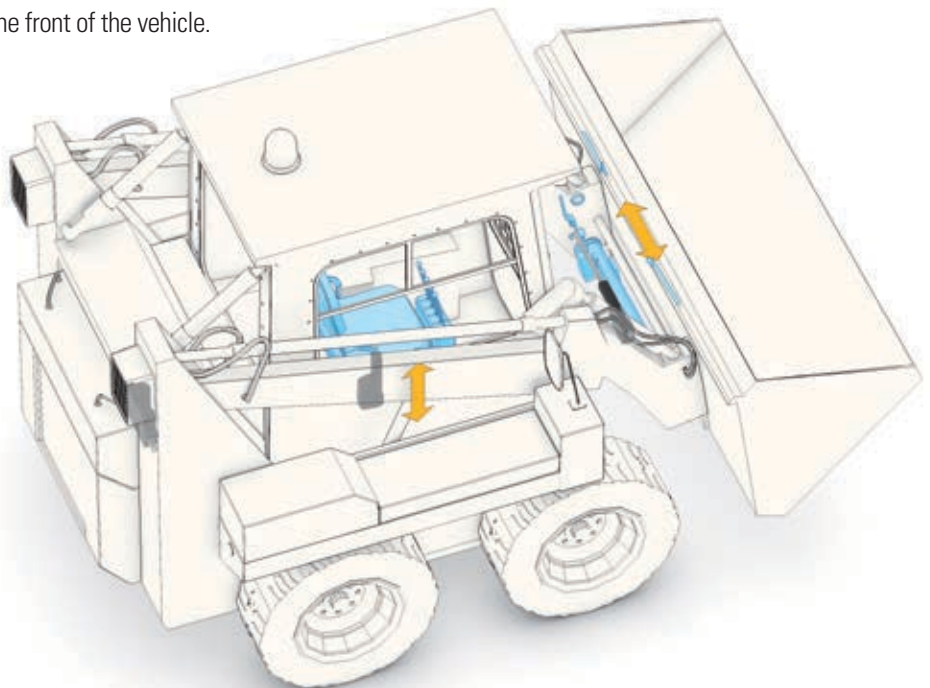

Marine Vessels

- Thomson smart actuators' rating for IP67 (static), IP69K (static) and IP66 (static/dynamic) address the strict sealing capabilities required by electronics integration.
- Corrosion-resistant coatings and surface treatments prevent oxidation in high-salinity environments.
- Applications include seat adjustments, engine hatch and wakeboard tower automation, and throttle and shift actuation.

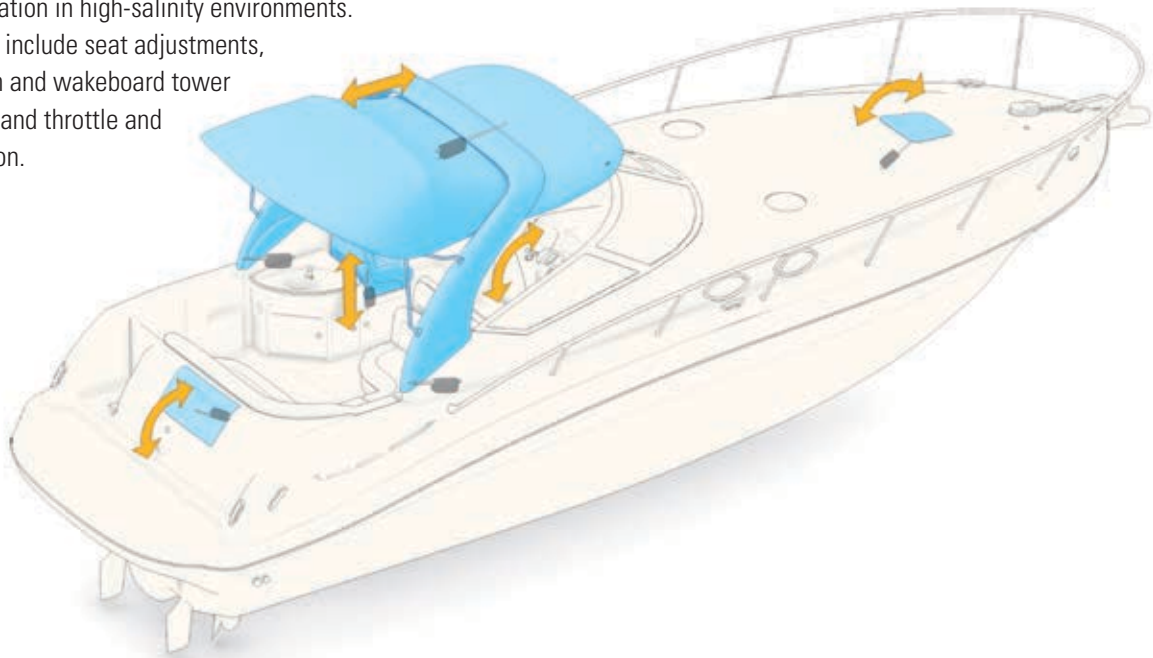

Public Transportation

- Smart actuation is more environmentally friendly and cost effective than hydraulic and pneumatic systems.
- Trains and buses using actuators for pantographs benefit from their robust construction to achieve long life in harsh environments.
- Overload sense and confirmed position are vital to user safety.
- Other public transit applications include door actuation, step leveling and gap control.

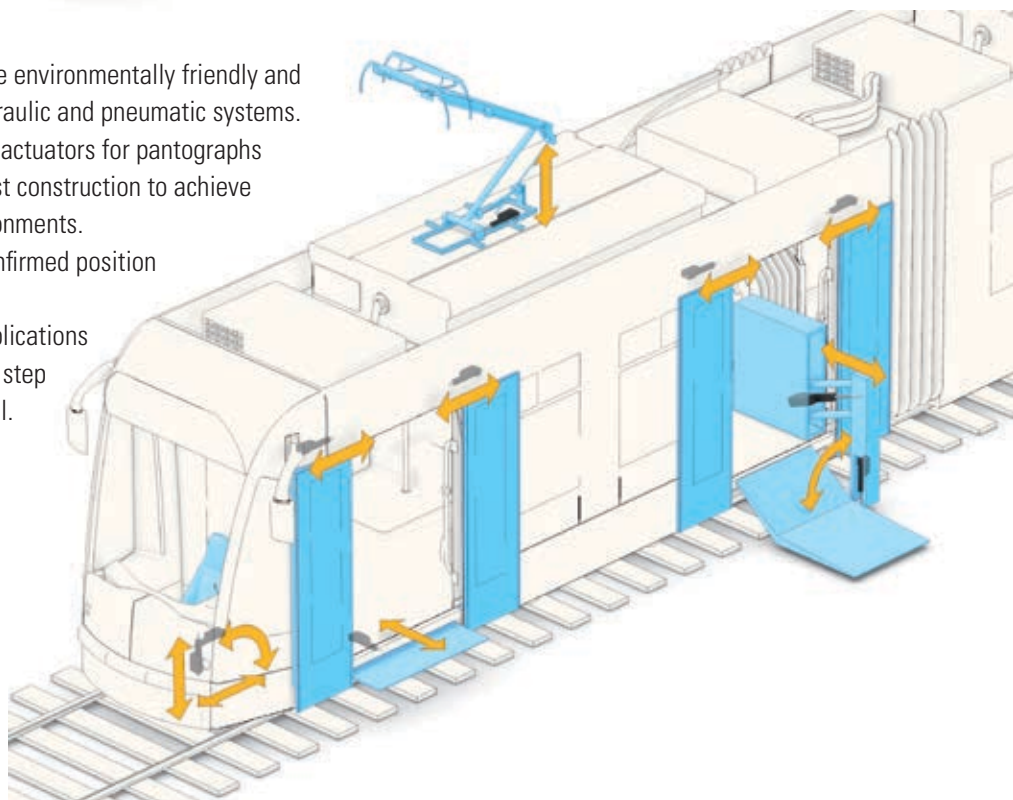

Making Structural Automation Smarter

In today's world, we often take for granted many luxuries that make our everyday lives easier. This allows us to focus more of our time and energy on getting our jobs done, relaxing comfortably or enjoying the company of loved ones. Smart actuation can be found integrated into many residential and commercial automation applications that afford us these luxuries.

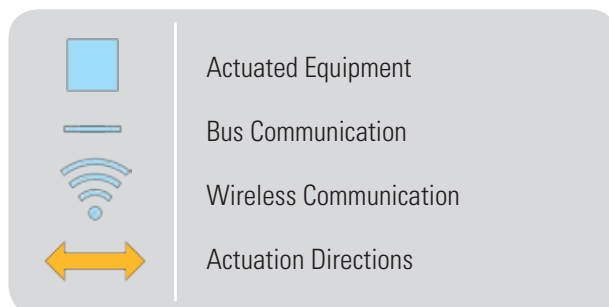
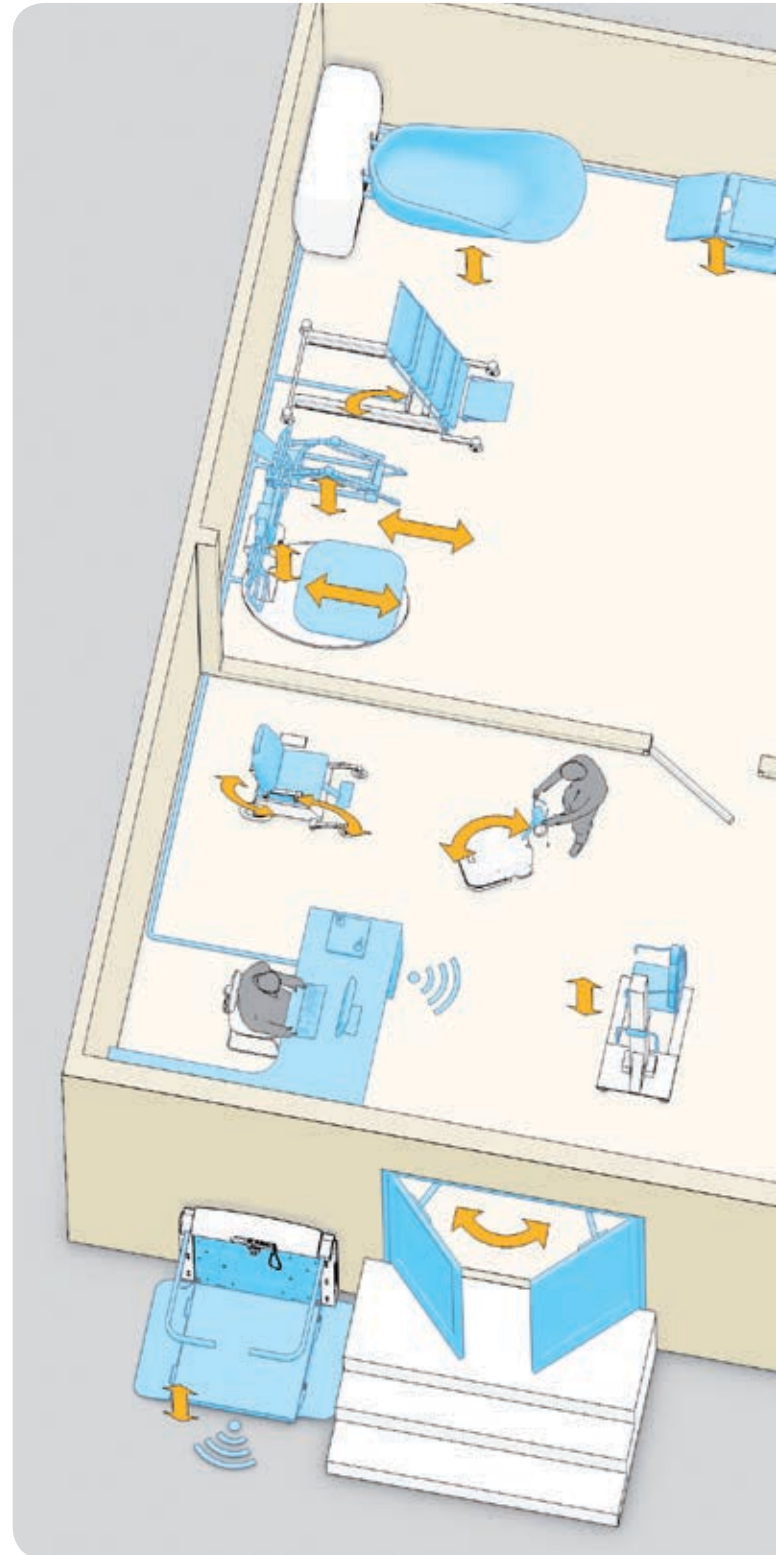

Improving Your Quality of Life

On any given day, you are more than likely benefitting from a structural automation application using smart actuation. At home on the patio, in your office, at the gym during your lunch break or in your doctor's office, your life is being made easier, more comfortable or just a little better thanks to a smart actuator.

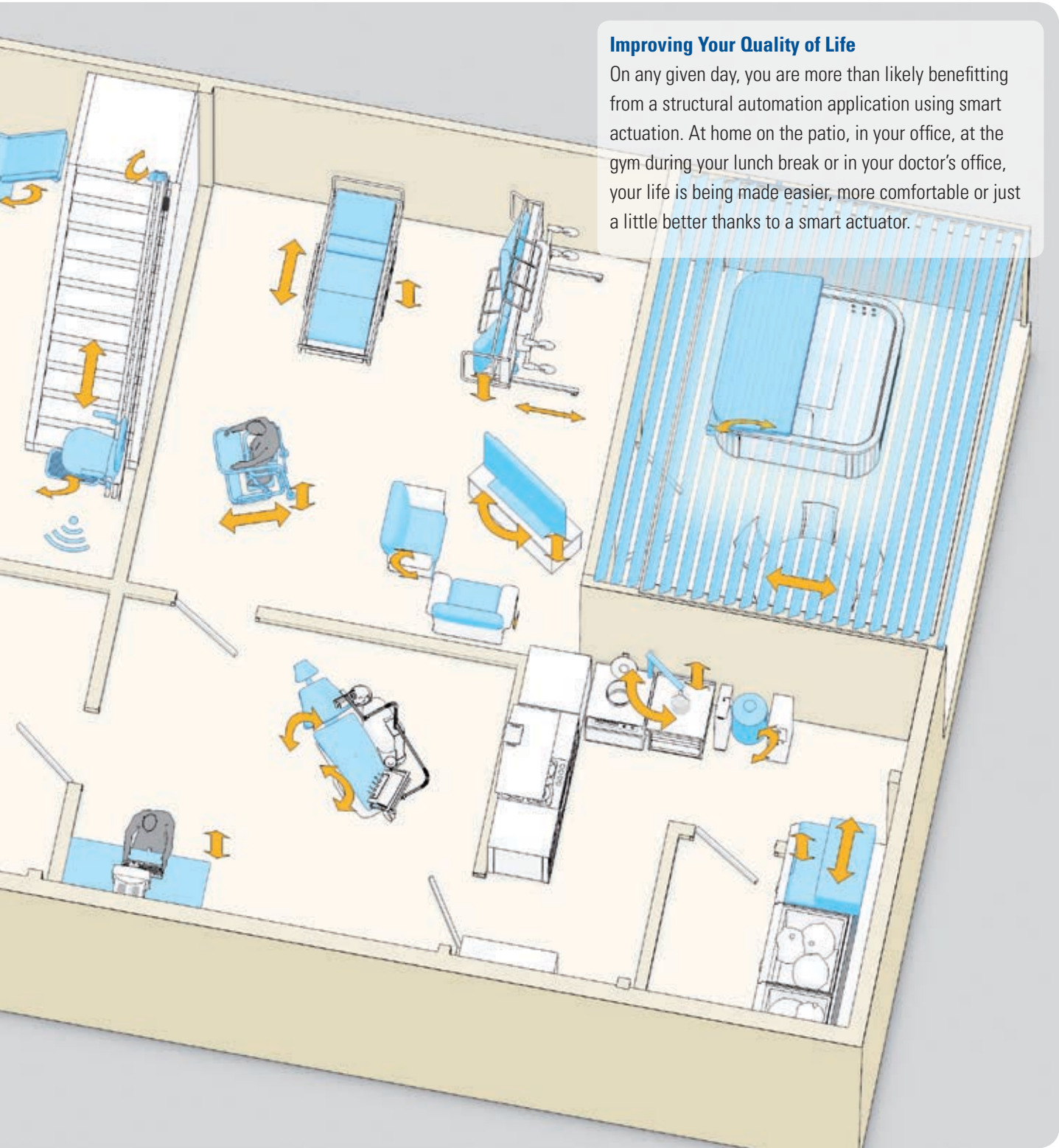

For further detail on structural automation applications that benefit from smart actuation, see the next page.

A Closer Look at Structural Automation

Patio Roofs

- Automated roof systems offer the convenience of a push-button solution to open and close the louvers on an outdoor pergola.
- The quiet and power-dense WhisperTrak™ actuator provides control with a variety of electronic feedback options.
- Provides hassle-free actuation to an otherwise manual operation.

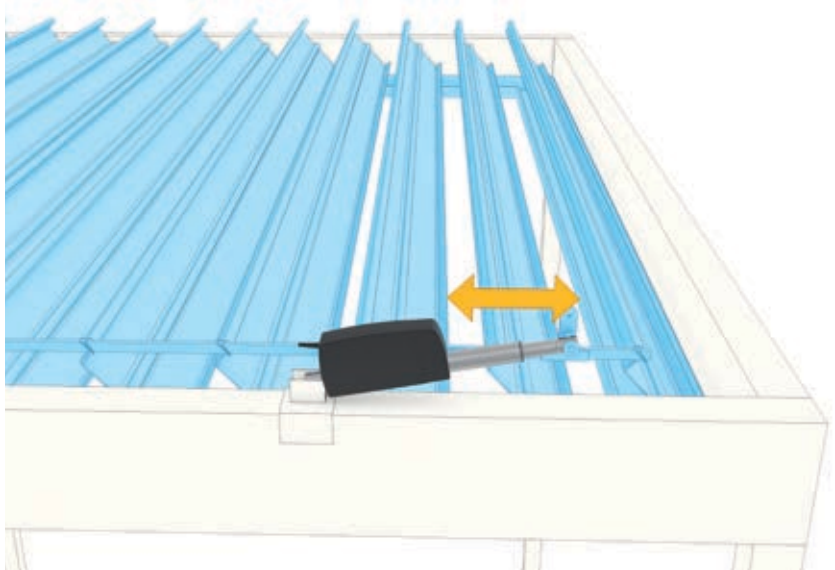

Kitchen Equipment

- Thomson smart actuators deliver enhanced controllability to industrial kitchen applications.
- OEMs benefit from an electromechanical solution that is cleaner and more efficient than many pneumatic and hydraulic alternatives.
- The actuators fit into the application without a complicated control package.

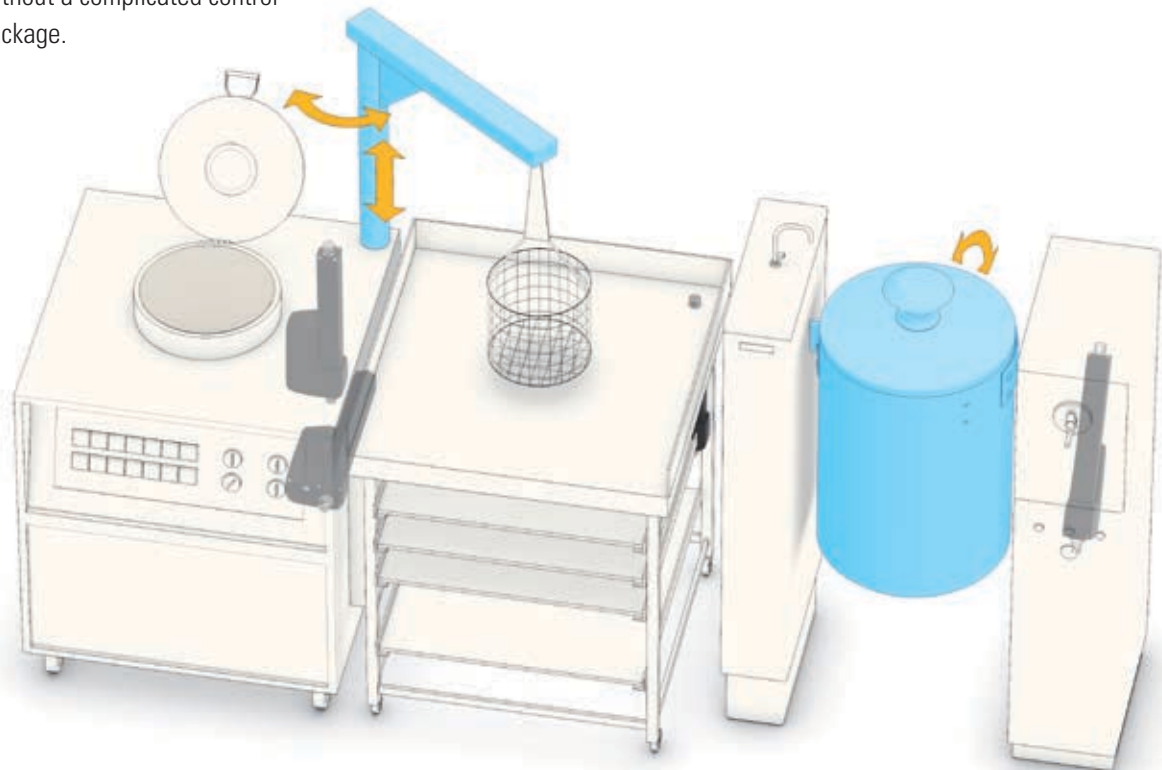

Garbage Compactors and Recycle Stations

- Employed primarily in commercial kitchens, bakeries, shops, restaurants and warehouses.
- Operate more quietly and easily with the use of electric actuation.

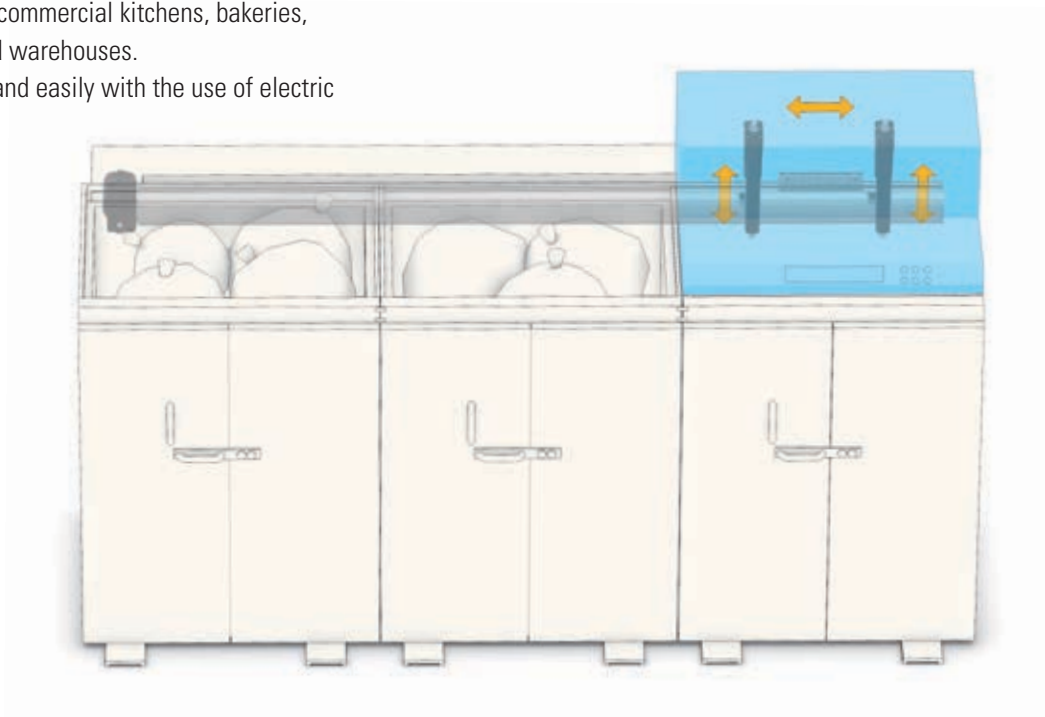

Staircase Lifts

- Used typically in homes or offices where electricity is the only available power source.
- Smart actuators are ideal for many lift functions depending on the style and configuration.
- Examples include seat leveling, tilting of the seat and foot rest, and extending and retracting the rail at the end of the staircase.

Thomson Actuators Overview

Actuator Features			
	Electrak® Original Range	Max Jac	
			
Control Technology Rating	★	★★	
Position Feedback Analog / Digital	YES / NO	YES / YES	
End-of-Stroke Protection Slip Clutch / ELS	YES / NO	NO / NO	
Overload Protection Slip Clutch / ELM	YES / NO	NO / NO	
Low-Level Switching	NO	NO	
J1939 CAN Bus Communication	NO	NO	
Synchronization	NO	NO	
Operation Monitoring Basic / EMP	NO	NO	
Load Capacity Rating	★★★★	★★	
Environmental Protection Rating	★★★★	★★★★★	

ELS: Electronic Limit Switch
ELM: Electronic Load Monitoring
EMP: Electronic Monitoring Package

	WhisperTrak™	Electrak Throttle	Electrak HD
			
	★ ★ ★	★ ★ ★ ★	★ ★ ★ ★ ★
	YES / YES	YES / NO	YES / YES
	NO / YES	YES / YES	NO / YES
	NO / YES	YES / YES	NO / YES
	YES	NO	YES
	NO	YES	YES
	YES	NO	YES
	YES / NO	YES / NO	YES / YES
	★ ★ ★	★	★ ★ ★ ★ ★
	★ ★ ★	★ ★ ★ ★ ★	★ ★ ★ ★ ★

Smart Actuators Overview

Electrak® HD

The Electrak HD sets the bar for the electric linear actuator platform. Onboard electronics can eliminate the need for standalone controls, higher power opens a wider range of hydraulic applications to electric conversion, and it meets the most extreme environmental acceptance tests.

More information: www.thomsonlinear.com/hd

Electrak Throttle

Simplify installation and increase operator safety and productivity with the space-saving design and electromechanical interface of Thomson Electrak Throttle linear actuators. These models allow engine speed controls for industrial vehicles to be placed in ergonomic positions. The rugged aluminum housing offers IP69K/IP67 sealing and is e-coated for corrosion resistance to make the throttle actuator maintenance-free.

More information: www.thomsonlinear.com/throttle

WhisperTrak™

Thomson WhisperTrak models are the quietest additions to our well-known electric linear actuator family. This actuator range sets the standard for medical, personal mobility, material handling, marine and structural automation applications. It is small, quiet, washdown-proof and robust.



More information: www.thomsonlinear.com/whispertrak

Custom Solutions

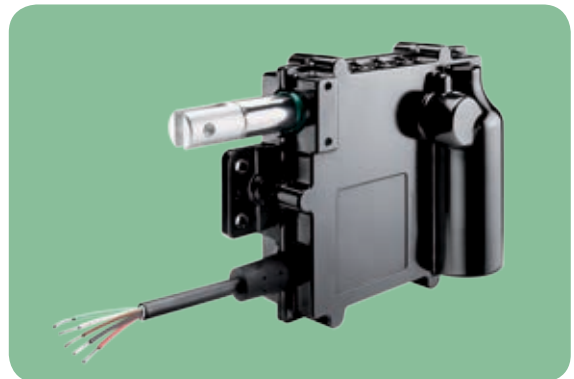
Even the most versatile actuator may not always suit all applications. Thomson engineers are ready to help you to customize the actuators according to your requirements. We build more custom actuators than anyone else and have decades of experience producing actuators to meet special needs.



Specifications

	Electrak HD 	Electrak Throttle 	WhisperTrak 
Screw type	ball	lead	lead
Nut type	load lock ball nut	self-locking lead nut	self-locking lead nut
Manual override	yes	no	no
Anti-rotation	yes	yes	yes
Dynamic braking	yes	optional	optional
Static load holding	yes (brake)	yes (self locking)	yes (self locking)
End-of-stroke protection	internal limit switches	optional	optional
Overload protection	yes	yes	optional
Temperature monitoring	yes	yes	yes
Voltage monitoring	yes	yes	no
Synchronization	optional	no	no
Available input voltages [VDC]	12, 24	12, 24	12, 24
Max. static load ⁽¹⁾ [N (lbs)]	18000 (4050)	260 (60)	4000 (900)
Max. dynamic load (Fx) [N (lbs)]	10000 (2248)	130 (30)	4000 (900)
Speed @ no load/max. load [mm/s (in/s)]	71/58 (2.80/2.28)	96/83 (3.70/3.30)	11/8 (0.43/0.31)
Max. ordering stroke (S) length [mm]	1000	50.8	500
Operating temperature limits [°C (F)]	- 40 - 85 (- 40 - 185)	- 40 - 85 (- 40 - 185)	-25 - 40 (-13 - 104)
Full load duty cycle @ 25 °C (77 °F) [%]	25	50	10
Protection class - static	IP67 / IP69K	IP67 / IP69K	IP67
Salt spray resistance [h]	500	500	not tested
Control options	<ul style="list-style-type: none"> • End-of-stroke output • Analog position feedback • Digital position feedback • Low-level switching • J1939 CAN bus • Synchronization 	<ul style="list-style-type: none"> • Extended temp. range • Analog position feedback • End-of-stroke limit switches • J1939 CAN bus 	<ul style="list-style-type: none"> • Electronic limit switches • Low-level switching • Analog position feedback • Digital position feedback • Synchronization

Smart Online Resources

Thomson offers a wide variety of online tools to help you in the selection process. An experienced team of application engineers is also available to help size and select a smart actuator model to best fit your needs. To explore additional technical resources and options, contact Thomson customer support at www.thomsonlinear.com/contact.

LinearMotioneering for Linear Actuators

Coming soon, this tool makes choosing the right actuator for your application simple.



Special-Purpose Websites

The fastest way to get all the relevant information on hot topics and new products.



Product Selectors

The product selector will walk you through the selection process.

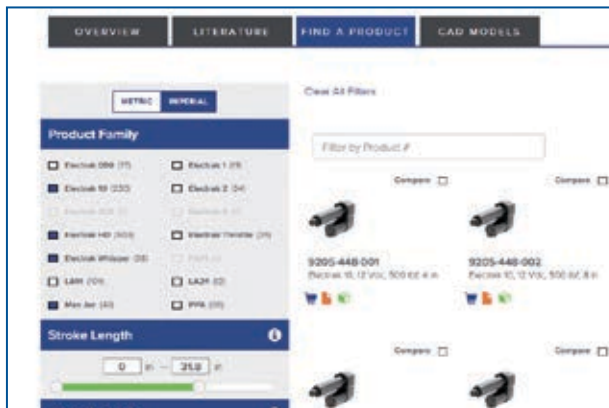

Interactive 3D CAD Models

Download free interactive 3D CAD models in the most common CAD formats.

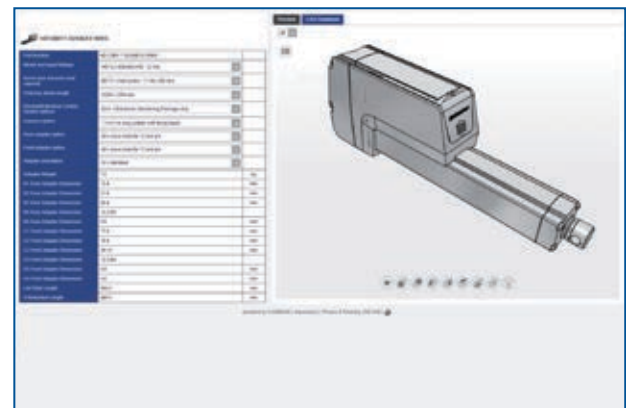

Getting Smarter Since 1965

Thomson is a leader for electromechanical linear actuators in the most demanding applications, including construction and agriculture vehicles. We routinely collaborate with original equipment manufacturers globally to solve problems, boost efficiency and enhance the value passed on to their customers.



1965
Thomson **Performance Pak** electromechanical actuators are developed.



1967
The first actuators for use in **garden tractors** and **farm equipment** are released.



1974
First line of actuators with parallel motors and both acme and ball screw drives is released.



1982
The **Electrak®** line of actuators is released.



1987
Electrak 205 and the first line of **MCS controls** are released.



2007
Electrak Pro Series is released.



2012
WhisperTrak™ Series is released.



2013
Electrak Throttle is released.



2013
Max Jac heavy duty actuator is released.



2016
Electrak HD is released.



Frequently Asked Questions

Here are the answers to common questions. Please contact customer support if you need more information at www.thomsonlinear.com/cs.

How many actuators can be controlled over J1939 CAN bus?

As many as the bus will allow, but physically up to 256 on the same network according to the J1939 protocol.

Where can I get more CAN bus information?

Contact Thomson customer support for all J1939 needs with our smart industrial linear actuators. Further information about the J1939 specifications can be found from SAE International at www.sae.org.

What are IP ratings?

International Protection Marking (IP) ratings are commonly referenced standards that classify electrical equipment using standard tests to determine resistance to ingress of solid objects (first digit) and liquids (second digit). See the IP Ratings table below.

How is the duty cycle determined?

The duty cycle = on time / on time + off time. For example, if an actuator is powered for 15 seconds and then off for 45 seconds, the duty cycle for that minute would be 25%. All models have a specific rating at full load at an ambient temperature of 25°C (77°F). If load and/or ambient temperature are lower, then the duty cycle can exceed the rating. At higher temperatures, the duty cycle will be lower.

Are Electrak® and WhisperTrak™ actuators maintenance free?

Yes. They never require lubrication, maintenance or adjustment for wear.

IP Rating		
Code	First Digit Definition	Second Digit Definition
0	No protection.	No protection.
1	Protected against solid objects over 50 mm.	Protected against vertically falling drops of water.
2	Protected against solid objects over 12.5 mm.	Protected against vertically falling drops of water, if the case is disposed up to 15° from vertical
3	Protected against solid objects over 2.5 mm.	Protected against vertically falling drops of water, if the case is disposed up to 60° from vertical
4	Protected against solid objects over 1 mm.	Protected against splash water from any direction.
5	Limited protection against dust ingress (no harmful deposits).	Protected against low-pressure water jets from any direction. Limited ingress permitted.
6	Totally dust protected.	Protected against high-pressure water jets from any direction. Limited ingress permitted.
7	–	Protected against short periods of immersion in water.
8	–	Protected against long, durable periods of immersion in water.
9K	–	Protected against close-range, high-pressure, high-temperature spray downs.

Is it possible for a load to back-drive the extension tube on an Electrak or WhisperTrak actuator?

No. They either have an anti-back-drive brake or are self locking.

Can Electrak or WhisperTrak be side loaded?

No. A proper design of the application should eliminate any side loads.

What is manual override?

Manual override allows the actuator extension tube to be moved manually by inserting a crank in the manual override input, which can be useful at power downs or other electrical failures.

What is anti-rotation?

Anti-rotation allows the extension tube to be moved without having the actuator mounted to the front and rear adapters. Without anti-rotation, the extension tube would not move but just rotate in such a situation.

What is dynamic braking?

Dynamic braking means that the motor windings are short circuited at power off, which results in faster and more accurate stops. On actuators with dynamic braking, this feature is built into the actuator. On those without, dynamic braking can be achieved by adding external circuitry.

What are the most common reasons for premature actuator failure?

Side load due to incorrect mounting, shock loading, exceeding the duty cycle and incorrect wiring are the most prominent causes for premature failure.

Can Thomson supply controls for the actuators?

Yes. Thomson offers a range of controls for different purposes. Contact customer support for more information or visit www.thomsonlinear.com/ILA_controls.

Can Electrak or WhisperTrak actuators be customized?

Yes. Thomson can do almost anything – from a smaller alteration to a white paper design. Contact customer support for more information.

USA, CANADA and MEXICO

Thomson
203A West Rock Road
Radford, VA 24141, USA
Phone: 1-540-633-3549
Fax: 1-540-633-0294
E-mail: thomson@thomsonlinear.com
Literature: literature.thomsonlinear.com

EUROPE

United Kingdom

Thomson
Office 9, The Barns
Caddsdow Business Park
Bideford, Devon, EX39 3BT
Phone: +44 (0) 1271 334 500
E-mail: sales.uk@thomsonlinear.com

Germany

Thomson
Nürtinger Straße 70
72649 Wolfschlugen
Phone: +49 (0) 7022 504 0
Fax: +49 (0) 7022 504 405
E-mail: sales.germany@thomsonlinear.com

France

Thomson
Phone: +33 (0) 243 50 03 30
Fax: +33 (0) 243 50 03 39
E-mail: sales.france@thomsonlinear.com

Italy

Thomson
Largo Brughetti
20030 Bovisio Masciago
Phone: +39 0362 594260
Fax: +39 0362 594263
E-mail: sales.italy@thomsonlinear.com

Spain

Thomson
E-mail: sales.esm@thomsonlinear.com

Sweden

Thomson
Estridsväg 10
29109 Kristianstad
Phone: +46 (0) 44 24 67 00
Fax: +46 (0) 44 24 40 85
E-mail: sales.scandinavia@thomsonlinear.com

ASIA

Asia Pacific

Thomson
E-mail: sales.apac@thomsonlinear.com

China

Thomson
Rm 2205, Scitech Tower
22 Jianguomen Wai Street
Beijing 100004
Phone: +86 400 6661 802
Fax: +86 10 6515 0263
E-mail: sales.china@thomsonlinear.com

India

Thomson
c/o CNRG Energy India Pvt. Ltd.
Unit No. FF A 07
Art Guild House, A Wing, 1st Floor, L.B.S Marg
Kurla – West, Mumbai – 400070 India
Phone: +0091 22 6249 5043
Email: sales.india@thomsonlinear.com

Japan

Thomson
Minami-Kaneden 2-12-23, Suita
Osaka 564-0044 Japan
Phone: +81-6-6386-8001
Fax: +81-6-6386-5022
E-mail: csjapan@scgap.com

South Korea

Thomson ROA
704 ASEM Tower (Samsung-dong)
517 Yeongdong-daero, Gangnam-gu
Seoul, S. Korea, Zip Code: 06164
Phone: +82 2 6917 5048 & 5049
Fax: +82 2 528 1456 & 1457
E-mail: sales.korea@thomsonlinear.com

SOUTH AMERICA

Brazil

Thomson
Av. Tamboré, 1077
Barueri, SP - 06460-000
Phone: +55 11 3616-0191
Fax: +55 11 3611 1982
E-mail: sales.brasil@thomsonlinear.com

www.thomsonlinear.com

Smart_Actuation_BREN-0027-02 | 20170925KB

Specifications are subject to change without notice. It is the responsibility of the product user to determine the suitability of this product for a specific application. All trademarks property of their respective owners. ©2017 Thomson Industries, Inc.



**DISTRIBUIDOR
AUTORIZADO**

MEX (55) 53 63 23 31
QRO (442) 1 95 72 60

MTY (81) 83 54 10 18
ventas@industrialmagza.com

THOMSON

Linear Motion. Optimized.™